

GENERAC®

POWER SYSTEMS, INC.

Owner's Manual

100 Amp "V" Type

Transfer Switch

Models:



9227-2



4678-1



This manual should remain with the unit.



 **Read the following information carefully before attempting to install, operate or service this equipment. Also read the instructions and information on tags, decals, and labels that may be affixed to the transfer switch. Replace any decal or label that is no longer legible.** 

 **DANGER! Connection of a generator to an electrical system normally supplied by an electric utility shall be by means of a double throw switch so as to isolate the electric system from utility distribution system when the generator is operating (NEC 701). Failure to isolate electric system by these means results in damage to generator and may result in injury or death to utility workers due to backfeed of electrical energy.** 

Generac cannot possibly anticipate every possible circumstance that might involve a hazard. The warnings in this manual, and on tags and decals affixed to the unit are, therefore, not all-inclusive. If you use a procedure, work method or operating technique Generac does not specifically recommend, you must satisfy yourself that it is safe for you and others. You also must make sure the procedure, work method or operating technique that you choose does not render the transfer switch unsafe.

Throughout this publication, and on tags and decals affixed to the generator, DANGER, WARNING, CAUTION and NOTE blocks are used to alert you to special instruction about a particular operation that may be hazardous if performed incorrectly or carelessly. Observe them carefully. Their definitions are as follows:

—  **DANGER**  —

After this heading, you can read instructions that, if not strictly complied with, will result in personal injury or property damage.

—  **WARNING**  —

After this heading, you can read instructions that, if not strictly complied with, may result in personal injury or property damage.

—  **CAUTION**  —





After this heading, you can read instructions that, if not strictly complied with, could result in damage to equipment and/or property.

NOTE:

After this heading, you can read explanatory statements that require special emphasis.

These safety warnings cannot eliminate the hazards that they indicate. Common sense and strict compliance with the special instructions while performing the service are essential to preventing accidents.

Four commonly used safety symbols accompany the DANGER, WARNING and CAUTION blocks. The type of information each indicates follows:

-  This symbol points out important safety information that, if not followed, could endanger personal safety and/or property of you and others.
-  This symbol points out potential explosion hazard.
-  This symbol points out potential fire hazard.
-  This symbol points out potential electrical shock hazard.

 **GENERAL HAZARDS** 

- Any AC generator that is used for backup power if a NORMAL (utility) power source failure occurs, must be isolated from the NORMAL (utility) power source by means of an approved transfer switch. Failure to properly isolate the NORMAL and STANDBY power sources from each other may result in injury or death to electric utility workers, due to backfeed of electrical energy.
- Improper or unauthorized installation, operation, service or repair of the equipment is extremely dangerous and may result in death, serious personal injury, or damage to equipment and/or personal property.
- Extremely high and dangerous power voltages are present inside an installed transfer switch. Any contact with high voltage terminals, contacts or wires will result in extremely hazardous, and possibly LETHAL, electric shock. **DO NOT WORK ON THE TRANSFER SWITCH UNTIL ALL POWER VOLTAGE SUPPLIES TO THE SWITCH HAVE BEEN POSITIVELY TURNED OFF.**
- Competent, qualified personnel should install, operate and service this equipment. Adhere strictly to local, state and national electrical and building codes. When using this equipment, comply with regulations the National Electrical Code (NEC) and Occupational Safety and Health Administration (OSHA) have established.
- Never handle any kind of electrical device while standing in water, while barefoot, or while hands or feet are wet. **DANGEROUS ELECTRICAL SHOCK MAY RESULT.**

- Because jewelry conducts electricity, wearing it may cause dangerous electrical shock. Remove all jewelry (such as rings, watches, bracelets, etc.) before working on this equipment.
- If you must work on this equipment while standing on metal or concrete, place insulative mats over a dry wood platform. Work on this equipment only while standing on such insulative mats.
- Never work on this equipment while physically or mentally fatigued.
- Keep the transfer switch enclosure door closed and bolted at all times. Only qualified personnel should be permitted access to the switch interior.
- In case of an accident caused by electric shock, immediately shut down the source of electrical power. If this is not possible, attempt to free the victim from the live conductor but AVOID DIRECT CONTACT WITH THE VICTIM. Use a nonconducting implement, such as a rope or board, to free the victim from the live conductor. If the victim is unconscious, apply first aid and get immediate medical help.
- When an automatic transfer switch is installed for a standby generator set, the generator engine may crank and start at any time without warning. To avoid possible injury that might be caused by such sudden start-ups, the system's automatic start circuit must be disabled before working on or around the generator or transfer switch. Always set the Auto-Off-Manual switch to its OFF position before working on the equipment. Then place a "DO NOT OPERATE" tag on the transfer switch and on the generator.

Safety RulesInside Front Cover-1

Section 1 – General Information2

1.1 Introduction2

1.2 Equipment Description2

1.3 Transfer Switch Ratings Decal2

1.4 Transfer Switch Enclosure2

1.5 Safe Use Of Transfer Switch2

Section 2 – Installation.....3

2.1 Introduction to Installation3

2.2 Unpacking.....3

2.3 Mounting.....3

2.4 Connecting Power Source and Load Lines ..3

 2.4.1 2-Pole Mechanism3-4

2.5 Connecting Start Circuit Wires4

**Section 3 – Post Installation Start-Up
and Adjustments5**

3.1 Functional Tests & Adjustments5

3.2 Manual Operation5

3.3 Transfer Switch Voltage Checks6

3.4 Generator Tests Under Load.....6

Section 4 – Notes7

Section 5 – Electrical Data8

**Section 6 – Exploded Views and
Parts Lists.....9**

Section 7 – WarrantyBack Cover

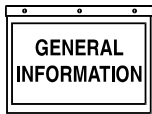

1.1 INTRODUCTION

This manual has been prepared especially for the purpose of familiarizing personnel with the design, application, installation, operation and servicing of the applicable equipment. Read the manual carefully and comply with all instructions. This will help to prevent accidents or damage to equipment that might otherwise be caused by carelessness, incorrect application, or improper procedures.

Every effort has been expended to make sure that the contents of this manual are both accurate and current. Generac, however, reserves the right to change, alter or otherwise improve the product at any time without prior notice.

1.2 EQUIPMENT DESCRIPTION

The pre-packaged transfer switch is designed to use with pre-packaged standby generator control panels. It is used for transferring critical electrical loads from a NORMAL (utility) power source. Such a transfer of loads occurs automatically when the NORMAL power source fails or is subsequently reduced and the STANDBY source voltage and frequency have reached an acceptable level. The transfer switch prevents electrical feedback between two different power sources (such as the NORMAL and STANDBY sources) and, for that reason, codes require it in all standby electric system installations.

Once the transfer is completed, the STANDBY power source then powers electrical loads connected to the transfer switch. When NORMAL source voltage above an acceptable (preset) level has been restored, voltage sensor action in the pre-packaged control panel initiates re-transfer back to NORMAL power source. After this re-transfer, the controller signals to open the start circuit to the generator, which shuts down the engine. The controller is then “armed” and ready for the next drop in NORMAL source voltage.

NOTE: Keep in mind the pre-packaged transfer switch is without any kind of electronic controls. It receives signals solely from the controller contained in the pre-packaged control panel.

1.3 TRANSFER SWITCH RATINGS DECAL

Affixed to the transfer switch door is a RATINGS DECAL. Use the transfer switch only within the specific limits shown on the RATINGS DECAL and on other decals and labels that may be affixed to the switch. This prevents damage to equipment and possible injury to personnel, and provides long and trouble-free life for the equipment.

When requesting information or ordering parts for this equipment, make sure to include all information from the RATINGS DECAL.

1.4 TRANSFER SWITCH ENCLOSURE

The standard switch enclosure is a National Electrical Manufacturer’s Association (NEMA) 1 type. NEMA 1 type enclosures primarily provide protection against contact with the enclosed equipment and against a limited amount of falling dirt.

1.5 SAFE USE OF TRANSFER SWITCH

Before installing, operating or servicing this equipment, read the SAFETY RULES (inside front cover) carefully. Comply strictly with all SAFETY RULES to prevent accidents and/or damage to the equipment. Generac recommends you make a copy of the SAFETY RULES and post them near the transfer switch. Also, be sure to read all instructions and information you may find on tags, labels and decals affixed to the equipment.

Two publications that outline the safe use of transfer switches are the following:

- National Electrical Code
- UL 1008, STANDARD FOR SAFETY-AUTOMATIC TRANSFER SWITCHES



2.1 INTRODUCTION TO INSTALLATION

This equipment has been wired and tested at the factory. Installing the switch includes the following procedures:

- Mounting the enclosure.
- Connecting power source and load leads.
- Connecting control wiring.
- Connecting any auxiliary contact (if needed)
- Installing/connecting any options and accessories.
- Testing functions.

2.2 UNPACKING

Carefully unpack the transfer switch. Inspect closely for any damage that might have occurred during shipment. The purchaser must file with the carrier any claims for loss or damage incurred while in transit.

Check that all packing material is completely removed from the switch prior to installation.

Attach any lifting device to the transfer switch mounting holes or brackets only. **DO NOT LIFT THE SWITCH AT ANY OTHER POINT.**

2.3 MOUNTING

Transfer switch components are generally mounted in a standard NEMA 1 type enclosure (Figure 2.1).



- Handle transfer switches carefully when installing. Do not drop the switch. Protect the switch against impact at all times, and against construction grit and metal chips. Never install a transfer switch that has been damaged.**

Figure 2.1 — Mounting Dimensions for Enclosures

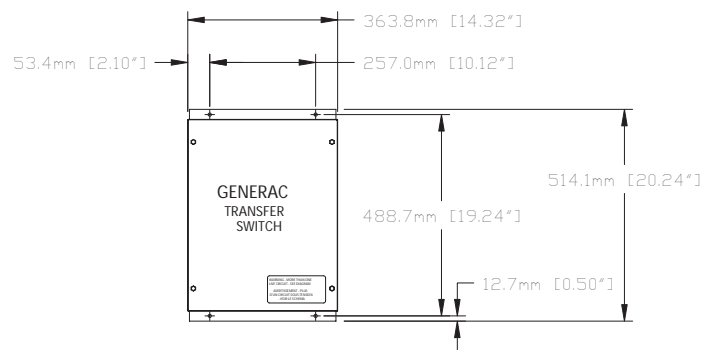

**ALL DIMENSIONS IN:
MILLIMETERS (INCHES)

Install the transfer switch as close as possible to the electrical loads that are to be connected to it. Mount the switch vertically to a rigid supporting structure. To prevent switch distortion, level all mounting points. If necessary, use washers behind mounting holes to level the unit.

2.4 CONNECTING POWER SOURCE AND LOAD LINES



- Make sure to turn OFF both the normal (Utility) and standby (generator) power supplies before trying to connect power source and load lines to the transfer switch. Supply voltages are extremely high and dangerous. Contact with such high voltage power supply lines causes extremely hazardous, possibly lethal, electrical shock.**

Wiring diagrams and electrical schematics are provided in this manual. Power source and load connections are made at a transfer mechanism, inside the switch enclosure.

2.4.1 2-POLE MECHANISM

This switch (Figure 2.2) is used with a single phase system, when the single phase NEUTRAL line is to be connected to a Neutral Lug and is not to be switched.

Figure 2.2 — 100 Amp 2-Pole Transfer Mechanism

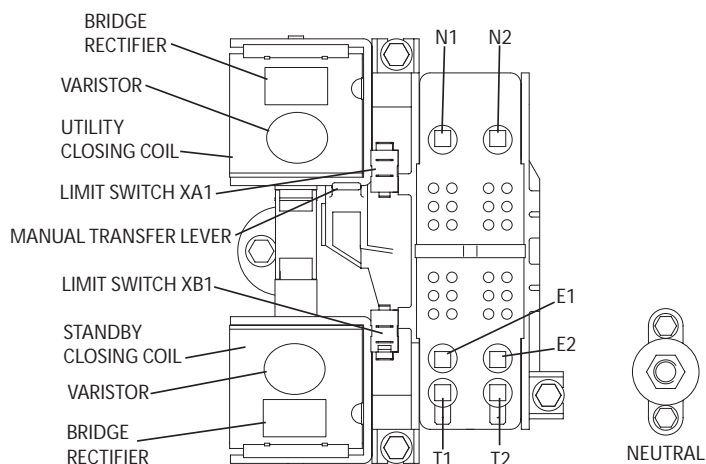

Solderless, screw-type terminal lugs are standard. Conductor sizes must be adequate to handle the maximum current to which they will be subjected. The installation must comply fully with all applicable codes, standards and regulations.

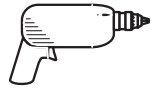

Before connecting wiring cables to terminals, remove any surface oxides from the cable ends with a wire brush. If ALUMINUM conductors are used, apply joint compound to conductors. After tightening terminal lugs, carefully wipe away any excess joint compound.

All power cables should enter the switch next to transfer mechanism terminals.

Connect power source load conductors to clearly marked transfer mechanism terminal lugs as follows (Figure 2.3).

1. Connect NORMAL (utility) power source cables to switch terminals N1 and N2.
2. Connect STANDBY source power cables to transfer switch terminals E1 and E2.
3. Connect customer LOAD leads to switch terminals T1 and T2.

Conductors must be properly supported, of approved insulative qualities, protected by approved conduit, and of the correct wire gauge size in accordance with applicable codes.

Tighten the wire into lugs to the following torque:

- 100 Amp Switch: 50 Inch-Pounds

Make sure to maintain proper electrical 1/2 inch clearance between live metal parts and grounded metal.

2.5 CONNECTING START CIRCUIT WIRES

Control system interconnections (Figure 2.3) consist of UTILITY 1 and 2, LOAD 1 and 2; and leads 23 and 194. Control system interconnection leads must be run in a conduit that is separate from the AC power lead. Recommended wire gauge sizes for this wiring depends on the length of the wire, as recommended below:

MAXIMUM WIRE LENGTH	RECOMMENDED WIRE SIZE
460 feet (140m)	No. 18 AWG.
730 feet (223m)	No. 16 AWG.
1,160 feet (354m)	No. 14 AWG.

Figure 2.3 — Transfer Switch Interconnections (Drawing No. C3921)

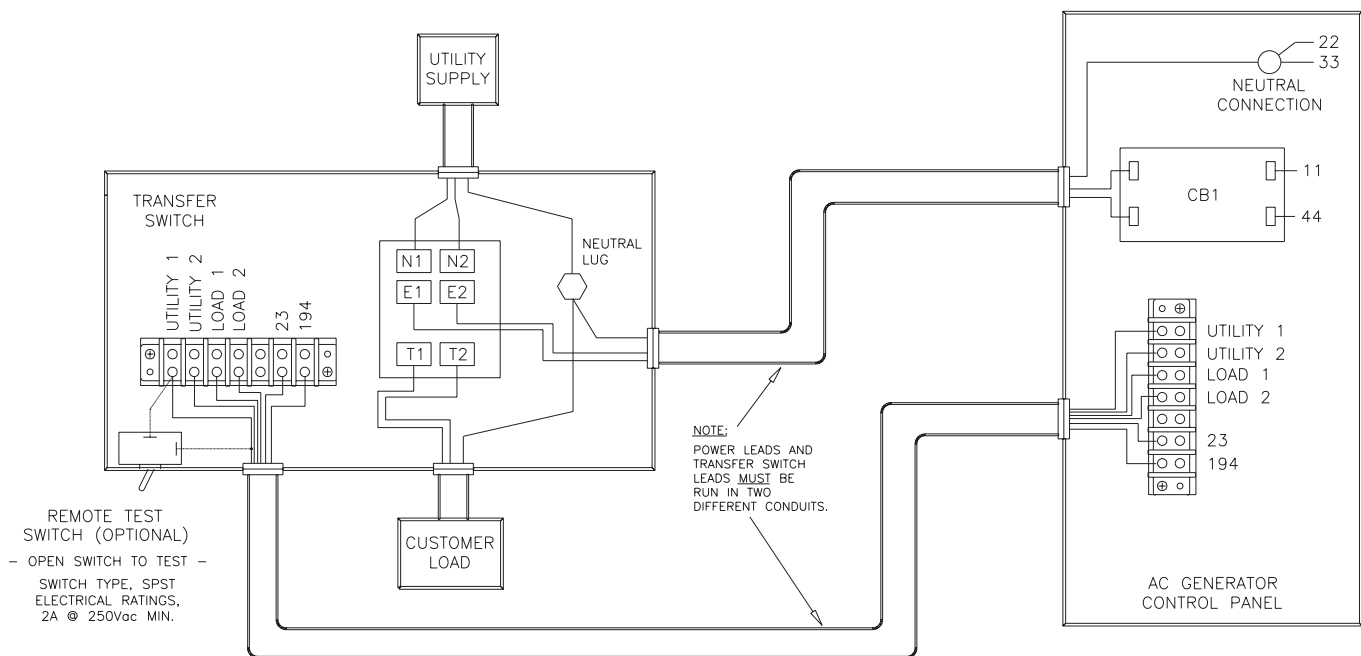

3.1 FUNCTIONAL TESTS AND ADJUSTMENTS

Following transfer switch installation and interconnection, inspect the entire installation carefully. A competent, qualified electrician should make the inspection.

The installation should comply strictly with all applicable codes, standards, laws and regulations. All electrical connections must be correct and in compliance with applicable codes and standards.

Make sure the standby generator is ready. This includes checking engine oil level, coolant level, fuel supply, batteries and other items specified in the Owner's Manual for specific generators.

Complete all functional tests as outlined in the Post Installation Start-Up Adjustments section. Do this before placing the transfer switch into service.

Functional tests of the transfer switch include these tests: (a) Manual Operation, (b) Voltage Checks and (c) Electric Operation.



⚠ To avoid damaging the transfer switch, perform functional test in the exact order given.

Before proceeding with functional tests, read and be sure you understand all instructions in this section. Also, read the instructions and information on tags and decals affixed to the transfer switch. Note any options and accessories that might be installed or provided with the switch and review their operation.



⚠ Do not attempt manual operation of the transfer switch until after all power voltage supplies to the switch have been turned off. Failure to turn off power voltage supplies may result in dangerous and possibly fatal electrical shock.

3.2 MANUAL OPERATION

Instructions for "V" type transfer switches: Test manual operation as follows:

1. Check that the generator's Auto-Off-Manual switch has been set to the OFF position.
2. Turn Off the UTILITY power supply to the transfer switch, using whatever means provided (such as the UTILITY source main line circuit breaker).
3. Set the generator's main circuit breaker to its Off or OPEN position.



- ⚠ Failure to turn OFF all power voltage supplies to the transfer switch before attempting manual operation results in extremely hazardous and possibly fatal electrical shock.**
4. Remove the manual transfer handle from the enclosure.
5. Place open slot of the manual transfer handle on the small tab of the transfer switch operating lever (Figure 3.1).
6. Pull manual transfer handle downward. If handle is down, LOAD is connected to STANDBY power source. If handle is up, LOAD is connected to UTILITY power.
7. Move the transfer switch main contact to both positions several times. Leave the transfer switch in the UTILITY position and connect LOAD to the UTILITY power source (manual operation lever is up).

Figure 3.1 — Transfer Switch Operation ("V" Type)

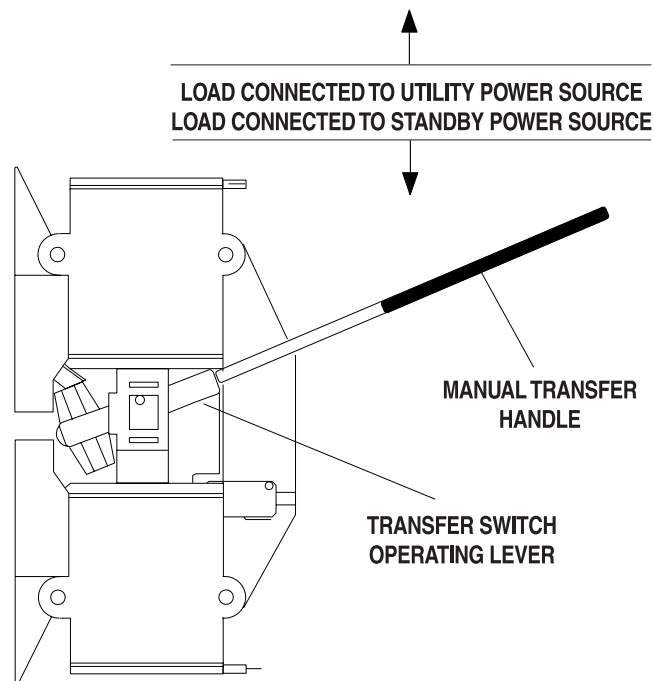

3.3 TRANSFER SWITCH VOLTAGE CHECKS

1. Turn ON the UTILITY power supply to the transfer switch with whatever means provided (such as the UTILITY main line circuit breaker).



 **Proceed with caution. The transfer switch is now electrically hot. Contact with live terminals results in extremely hazardous and possibly fatal electrical shock.**

2. With an accurate AC voltmeter, check for correct voltage across terminal lugs N1 and N2; N1 to NEUTRAL; and, finally, N2 to NEUTRAL (see Wiring Diagram on Page 8).
3. When certain that UTILITY supply voltage is correct and compatible with transfer switch ratings, turn **OFF the UTILITY** supply to the transfer switch.
4. On the generator panel, set the Auto-Off-Manual switch to MANUAL position. The generator should crank and start.
5. Let the generator stabilize and warm up at no-load for at least five minutes.
6. Set the generator's main circuit breaker (CB1) to its ON or CLOSED position.



 **Proceed with caution. Generator output voltage is now being delivered to transfer switch terminals. Contact with live terminals results in extremely dangerous and possibly fatal electrical shock.**

7. With an accurate AC voltmeter and frequency meter, check the no-load, voltage and frequency meter at transfer switch terminal lugs E1, E2 and NEUTRAL. Readings should be as follows:
 - a. Frequency.....61-63 Hz
 - b. Terminals E1 and E2242-253 volts
 - c. Terminal E1 to Neutral121-126 volts
 - d. Terminal E2 to Neutral121-126 volts
8. Set the generator's main circuit breaker (CB1) to its OFF or OPEN position.
9. To shut down the generator, set its Auto-Off-Manual switch to its OFF position.

NOTE:

Do NOT proceed until generator AC output voltage and frequency are correct and within stated limits. If the no-load voltage is correct but no-load frequency is incorrect, the engine governed speed probably requires adjustment. If no-load frequency is correct but voltage is not, the voltage regulator may require adjustment.

3.4 GENERATOR TESTS UNDER LOAD

1. Set the generator's main circuit breaker to its OFF or OPEN position.
2. Turn OFF utility power to the transfer switch.
3. Manually move the transfer switch main contacts to their STANDBY position.
4. To start the generator, set the Auto-Off-Manual switch to MANUAL. When engine starts, let it stabilize for a few minutes.
5. Turn the generator's main circuit breaker to its ON or CLOSED position. The generator now powers all LOAD circuits. Check generator operation under load as follows:
 - Turn ON electrical loads to the full rated wattage/ampere capacity of the generator. **DO NOT OVERLOAD.**
 - With maximum rated load applied, check voltage and frequency across transfer switch terminals E1 and E2. Voltage should be greater than 230 volts; frequency should be greater than 58 Hz.
 - Let the generator run under rated load for at least 30 minutes. With the unit running, listen for unusual noises, vibration, overheating, etc., that might indicate a problem.
6. When checkout under load is complete, set the generator's main circuit breaker to its OFF or OPEN position.
7. Let the generator run at no-load for several minutes. Then, shut down by setting the Auto-Off-Manual switch to its OFF position.
8. With the manual transfer handle, move the switch's main contacts back to their utility position, i.e., load connected to utility power supply. The handle and operating lever of the transfer switch should be in the up position.
9. Turn on the utility power supply to the transfer switch, using whatever means provided (such as a utility main line circuit breaker). The utility power source now powers the loads.
10. Set the generator's main circuit breaker to its ON or CLOSED position.
11. Set the generator's Auto-Off-Manual switch to its AUTO position. The system is now set for fully automatic operation.

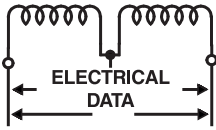

Section 5 – Electrical Data

Electrical Schematic – Drawing No. 81222-B

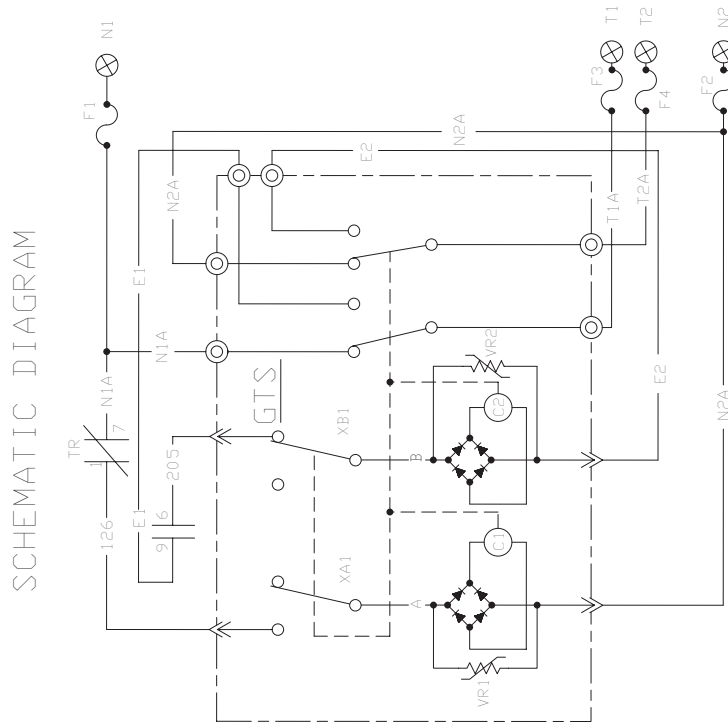
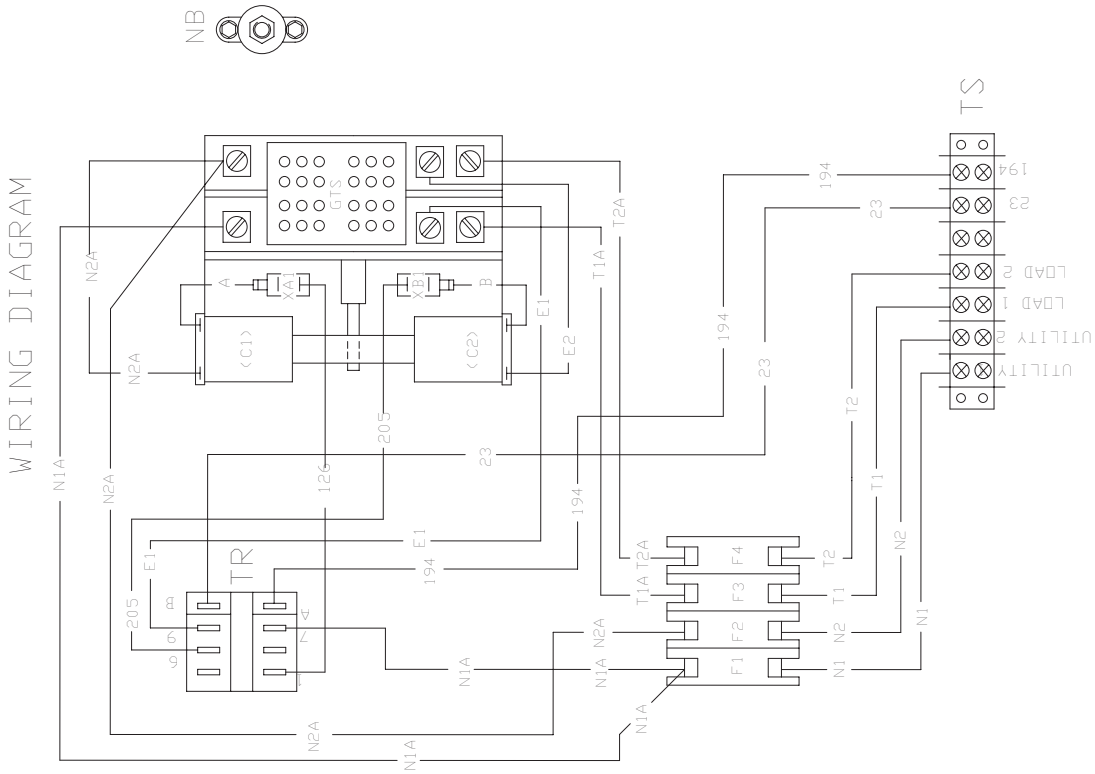

LEGEND	
C1-	SOLENOID COIL <UTILITY CLOSING>
C2-	SOLENOID COIL <STANDBY CLOSING>
GTS -	TRANSFER SWITCH CONTACTOR
TR -	RELAY, TRANSFER
TS -	TERMINAL STRIP <CUSTOMER CONNECTION>
XA1, XB1-	LIMIT SWITCHES, ACTUATOR
F1, F2, F3, F4-	FUSE, 5A SENSING
VR1, VR2 -	VARIATOR
NB -	NEUTRAL BLOCK

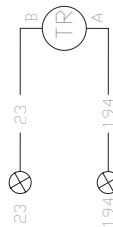

NOTE:
ALL CONTACTS SHOWN WITH
TRANSFER SWITCH IN UTILITY
POSITION.

Section 6 – Exploded Views and Parts Lists



Transfer Switch – Drawing No. C3909-A

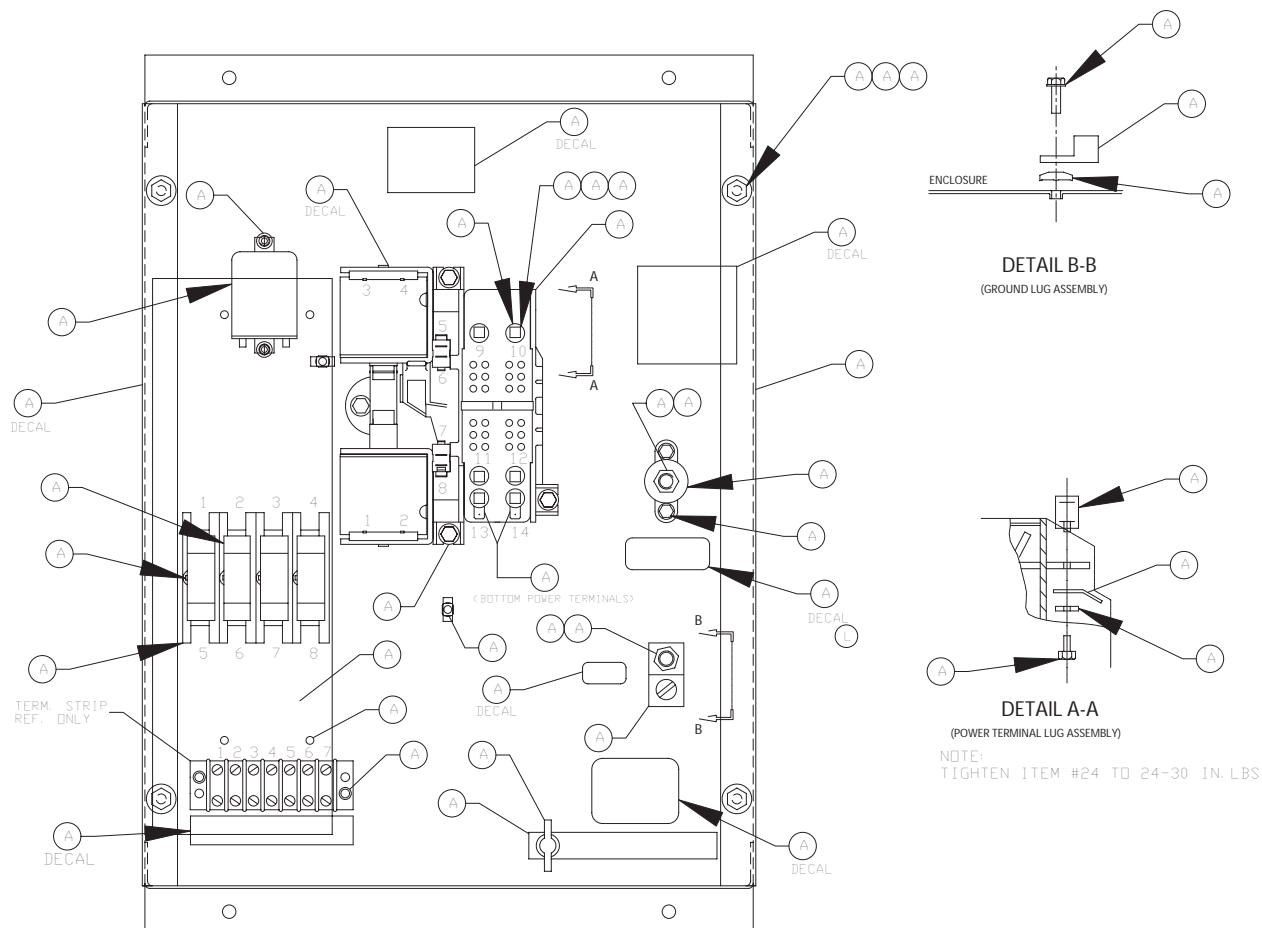

ITEM	PART NO.	QTY.	DESCRIPTION	ITEM	PART NO.	QTY.	DESCRIPTION
1	C2259	1	ENCLOSURE	26	77033	6	LUG, SOLDERESS
2	74975	1	COVER, ENCLOSURE	27	74138	2	MALE DISCONNECT ADAPTOR (BENT)
3	42568	4	HHCS M6-1.0 x 20	28	77052	2	LUG, 0.25"-TAB, #10-SCREW
4	22473	4	M6 FLAT WASHER	29*	81238	1	HARNESS, WIRE
5	22097	4	M6 LOCK WASHER	30	63378	2	CABLE TIE HOLDER
6	C2237	1	SWITCH, TRANSFER 100A 2-POLE, 250V	31	28739	2	TIE WRAP, 4"
7	74908	4	M5-0.8 x 10 TAPTITE	32	75353	1	DECAL, UL COMPONENT RECOGNITION
8	63617	1	RELAY, 12V-DC 10A	33	A9517	1	DECAL, MANUAL OPERATION
9	24940	6	#8-32 x 1/2" TAPTITE	34	A2595	1	DECAL, TERMINAL STRIP
10	73591	4	FUSE HOLDER	35	77030	1	DECAL, TRANSFER SWITCH RATING (9222-3)
11	73590A	4	FUSE 5A 600V				
12	57073	1	LUG, NEUTRAL				
13	66849	2	M5-0.8 x 16 TAPTITE	77032		1	DECAL, TRANSFER SWITCH RATING (9227-2)
14	27628	1	NUT, .375-16				
15	22131	1	WASHER, FLAT .375 NOM.	36**	77036	1	DECAL, TEST SEQUENCE
16	64113	1	STUD, WING	37	83736	1	DECAL, CSA(NOT FOR SALE)
17	77441	-	HANDLE, TRANSFER SWITCH	38***	95282	1	DECAL, LIVE CIRCUIT WARNING
18	62684	1	LUG, GROUND	39	81221	1	DECAL, NAMEPLATE UL (NOT FOR SALE)
19	24912	1	1/4"-20 x 5/8" TAPTITE				
20	A1658	1	LOCK WASHER 1/4" SPECIAL	40	67210A	1	DECAL, GROUND
21	C2630	1	COVER, RELAY & TERMINAL BLOCK	41	A9457	1	DECAL, NEUTRAL
22	40213B	4	STANDOFF 1-3/8" NYLON				
23	A1661	2	POP RIVET				
24	36932	6	PPHMS #10-32 x 1/4"				
25	22152	6	WASHER, LOCK #10				

* NOT SHOWN
 ** INSIDE OF COVER
 *** OUTSIDE OF COVER



Section 7 – Warranty

Generac 100 Amp Transfer Switch

GENERAC POWER SYSTEMS STANDARD TWO-YEAR LIMITED WARRANTY FOR GENERAC TRANSFER SWITCH SYSTEMS

For a period of 2 (two) years from the date of sale, Generac Power Systems, Inc. will, at its option, repair or replace any part(s) which, upon examination, inspection, and testing by Generac Power Systems or a Generac Power Systems Authorized Warranty Service Dealer, is found to be defective under normal use and service, in accordance with the warranty schedule set forth below. Any equipment that the purchaser/owner claims to be defective must be examined by the nearest Generac Power Systems Authorized Warranty Service Dealer. All transportation costs under the warranty, including return to the factory, are to be borne and prepaid by the purchaser/owner. This warranty applies only to Generac Power Systems Transfer Switch applications, as Generac Power Systems, Inc. have defined Transfer Switch application.

WARRANTY SCHEDULE

- **YEAR ONE** — 100% (one hundred percent) coverage labor, and parts listed.
 - **ALL COMPONENTS**
 - **YEAR TWO** — 100% (one hundred percent) coverage on parts listed.
 - **ALL COMPONENTS — *PARTS ONLY**
 - A Generac Power Systems, Inc. Transfer Switch is highly recommended to be used in conjunction with the genset. If a non Generac genset is substituted for use and directly causes damage to the Generac Transfer Switch, no warranty coverage shall apply.
 - All warranty expense allowances **are** subject to the conditions defined in Generac Power Systems Warranty, Policies, and Procedures Flat Rate Manual.
 - Units that have been resold **are not** covered under the Generac Power Systems Warranty, as this Warranty **is not** transferable.
- THIS WARRANTY SHALL NOT APPLY TO THE FOLLOWING:**
1. Any unit built/manufactured prior to January 1, 2002.
 2. Unit enclosure is only covered against rust or corrosion the first year of the warranty provision.
 3. Costs of normal maintenance i.e. tune-ups, associated part(s), adjustments, loose/leaking clamps, installation and start-up.
 4. Use of Non-Generac replacement part(s) will void the warranty in its entirety.
 5. Damage related to rodent infestation
 6. Failures due, but not limited to, normal wear and tear, accident, misuse, abuse, negligence, or improper installation or sizing.
 7. Failures caused by any external cause or act of God such as collision, fire, theft, freezing, vandalism, riot or wars, lightning, earthquake, windstorm, hail, volcanic eruption, water or flood, tornado, hurricane, terrorist acts or nuclear holocaust.
 8. Products that are modified or altered in a manner not authorized by Generac Power Systems in writing.
 9. Any incidental, consequential or indirect damages caused by defects in materials or workmanship, or any delay in repair or replacement of the defective part(s).
 10. Failure due to misapplication, or misrepresentation.
 11. Telephone, cellular phone, facsimile, internet access or other communication expenses.
 12. Living or travel expenses of person(s) performing service, except as specifically included within the terms of a specific unit warranty period.
 13. Rental equipment used while warranty repairs are being performed.
 14. Overtime labor.
 15. Expenses related to “customer instruction” or troubleshooting where no manufacturing defect is found.
 16. Overnight freight costs for replacement part(s).

THIS WARRANTY IS IN PLACE OF ALL OTHER WARRANTIES, EXPRESSED OR IMPLIED, SPECIFICALLY, GENERAC POWER SYSTEMS MAKES NO OTHER WARRANTIES AS TO THE MERCHANTABILITY OR FITNESS FOR A PARTICULAR PURPOSE. Some states do not allow limitations on how long an implied warranty lasts, so the above limitation may not apply to you.

GENERAC POWER SYSTEMS ONLY LIABILITY SHALL BE THE REPAIR OR REPLACEMENT OF PART(S) AS STATED ABOVE. IN NO EVENT SHALL GENERAC POWER SYSTEMS BE LIABLE FOR ANY INCIDENTAL, OR CONSEQUENTIAL DAMAGES, EVEN IF SUCH DAMAGES ARE A DIRECT RESULT OF GENERAC POWER SYSTEMS, INC. NEGLIGENCE.

Some states do not allow the exclusion or limitation of incidental or consequential damages, so the above limitations may not apply to you. Purchaser/owner agrees to make no claims against Generac Power Systems, Inc. based on negligence. This warranty gives you specific legal rights. You also may have other rights that vary from state to state.

**GENERAC® POWER SYSTEMS, INC.
P.O. BOX 297
WHITEWATER, WI 5319087**